

STEELMAN POWER CAPACITORS SPECIFICATION SHEET

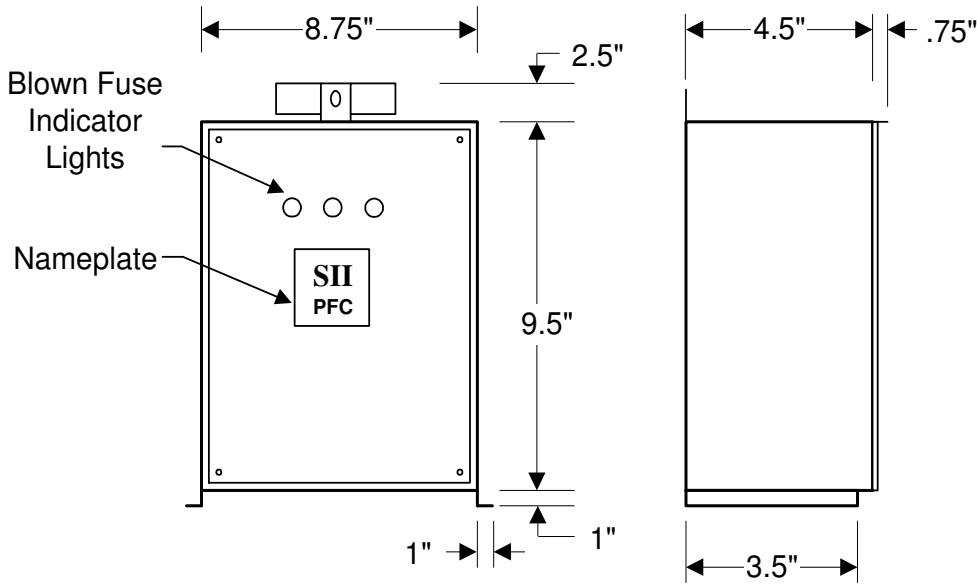

Internal Wiring Diagram

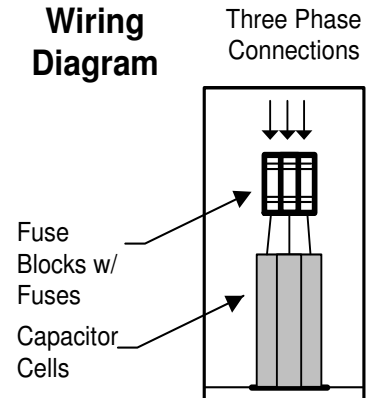

MODEL M001.5-480-FPL

1.5 KVAR 480 VOLT Fused with pilot lights

Three Phase 60 Hz NEMA 3R Enclosure

Rated Current: 1.8 Amps

Recommended Wire Size: 14 AWG

APPROX. WEIGHT 11 LBS. EACH

OPTIONS:

- *Pigtail- 5' electrical cord ready for connection
- *Built-In Contactor

Life Expectancy: 20 years

Temperature: -40°C to +50°C

Discharge Resistors: Included, will reduce residual voltage to less than 50 volts in one minute after removal from service.

Pressure Sensitive Interrupter in each capacitor cell.

Self Clearing Design

Enclosures are rated NEMA 3R, Outdoor/Indoor.
Provisions for wall, pole, or floor mounting are included.

TWO YEAR LIMITED WARRANTY!



STEELMAN INDUSTRIES, INC.

2800 HWY. 135 N P.O. BOX 1461 KILGORE, TEXAS 75662

PHONE: (903) 984-3061 FAX: (903) 984-1384