

# STEELMAN POWER CAPACITORS SPECIFICATION SHEET

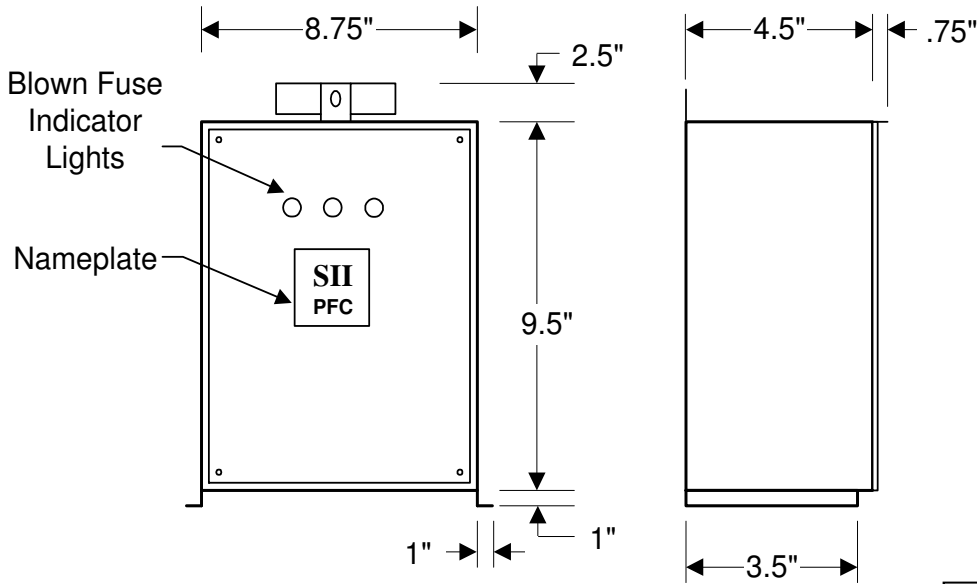

### Internal Wiring Diagram

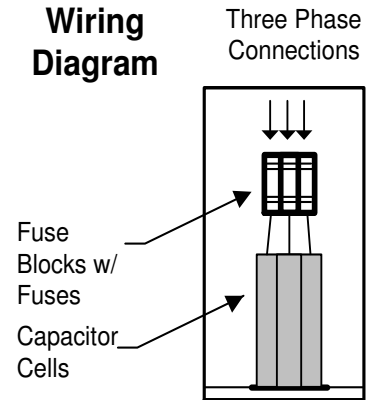

**MODEL M002.5-480-FPL**  
**2.5 KVAR 480 VOLT Fused with pilot lights**  
**Three Phase 60 Hz NEMA 3R Enclosure**  
**Rated Current: 3.0 Amps**  
**Recommended Wire Size: 14 AWG**  
**APPROX. WEIGHT 12 LBS. EACH**

**Life Expectancy: 20 years**  
**Temperature: -40°C to +50°C**  
**Discharge Resistors: Included, will reduce residual voltage to less than 50 volts in one minute after removal from service.**  
**Pressure Sensitive Interrupter in each capacitor cell.**

**Self Clearing Design**

**OPTIONS:**

- \*Pigtail- 5' electrical cord ready for connection
- \*Built-In Contactor

STEELMAN ADVANTAGE OPTION

600Volt, 70°C rated capacitors

ENHANCES CAPACITOR LIFE & PERFORMANCE CHARACTERISTICS

Enclosures are rated NEMA 3R, Outdoor/Indoor. Provisions for wall, pole, or floor mounting are included.

**TWO YEAR LIMITED WARRANTY!**



**STEELMAN INDUSTRIES, INC.**

2800 HWY. 135 N      P.O. BOX 1461      KILGORE, TEXAS 75662  
 PHONE: (903) 984-3061      FAX: (903) 984-1384