

# STEELMAN POWER CAPACITORS SPECIFICATION SHEET

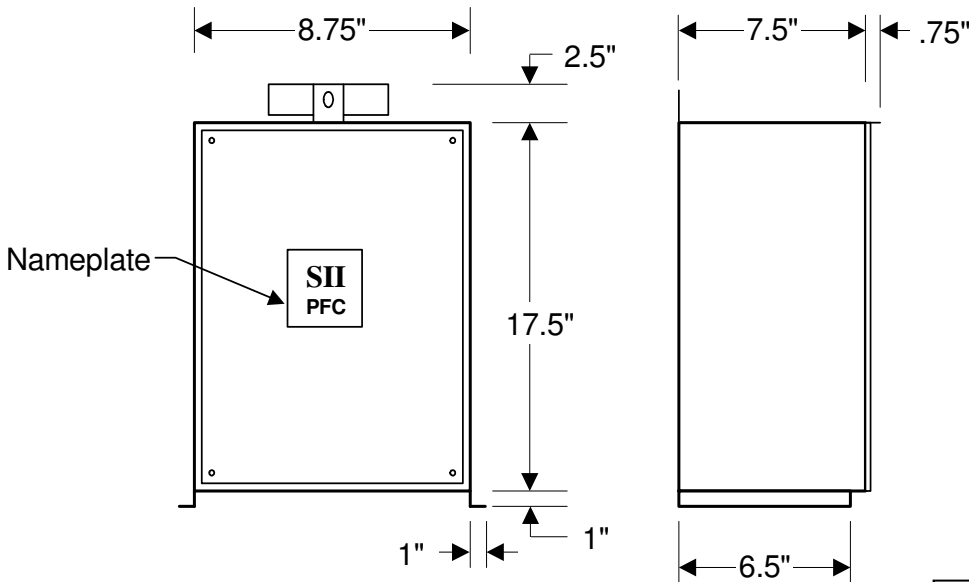

## Internal Wiring Diagram

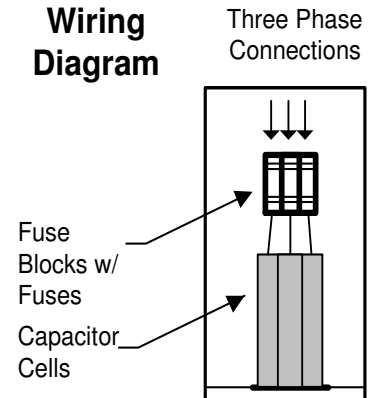

**MODEL M018.0-480-F**  
**18.0 KVAR 480 VOLT Fused**  
**Three Phase 60 Hz NEMA 3R Enclosure**  
**Rated Current: 21.7 Amps**  
**Recommended Wire Size: 8 AWG**  
**APPROX. WEIGHT 25 LBS. EACH**

### OPTIONS:

- ◆ Pigtail- 5' electrical cord ready for connection (up to 25KVAR)
- ◆ Built-In Contactor
- ◆ 3<sup>rd</sup> Leg Fusing

Enclosures are rated NEMA 3R, Outdoor/Indoor.  
 Provisions for wall, pole, or floor mounting are included.

**Life Expectancy: 20 years**  
**Temperature: -40°C to +50°C**  
**Discharge Resistors: Included, will reduce residual voltage to less than 50 volts in one minute after removal from service.**  
**Pressure Sensitive Interrupter in each capacitor cell.**

**Self Clearing Design**

### STEELMAN ADVANTAGE OPTION

600Volt, 70°C rated capacitors

ENHANCES CAPACITOR  
 LIFE & PERFORMANCE  
 CHARACTERISTICS

**TWO YEAR LIMITED WARRANTY!**



**STEELMAN INDUSTRIES, INC.**

2800HWY. 135 N P.O. BOX 1461 KILGORE, TEXAS 75662  
 PHONE: (903) 984-3061 FAX: (903) 984-1384