

STEELMAN POWER CAPACITORS SPECIFICATION SHEET

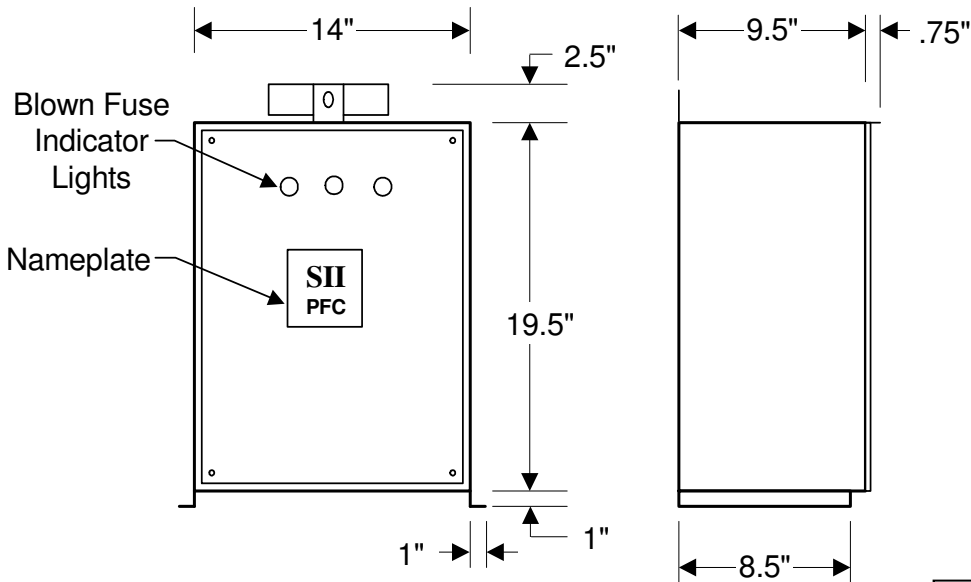

Internal Wiring Diagram

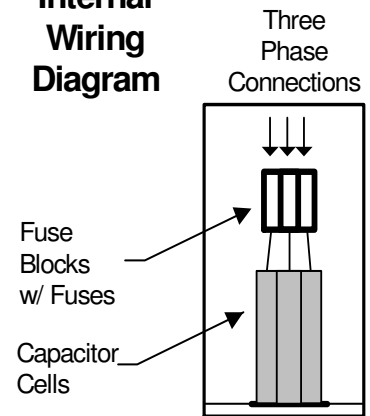

MODEL M019.0-240-FPL
19 KVAR 240VOLT Fused with Pilot Lights
Three Phase 60 Hz NEMA 3R Enclosure
Rated Current: 45.7 Amps
Recommended Wire Size: 6 AWG
APPROX. WEIGHT 52 LBS. EACH

OPTIONS:

- ◆ Built-In Contactor
- ◆ Built-In Circuit Breaker
- ◆ Third Leg Fusing

Life Expectancy: 20 years
Temperature: -40°C to +50°C
Discharge Resistors: Included, will reduce residual voltage to less than 50 volts in one minute after removal from service.
Pressure Sensitive Interrupter in each capacitor cell.

Self Clearing Design

Enclosures are rated NEMA 3R, Outdoor/Indoor.
 Provisions for wall, pole, or floor mounting are included.

STEELMAN ADVANTAGE OPTION

480Volt, 70°C rated capacitors

ENHANCES CAPACITOR
 LIFE & PERFORMANCE
 CHARACTERISTICS



TWO YEAR LIMITED WARRANTY!

STEELMAN INDUSTRIES, INC.

2706 HWY. 135 N P.O. BOX 1461 KILGORE, TEXAS 75662
 PHONE: (903) 984-3061 FAX: (903) 984-1384