

STEELMAN POWER CAPACITORS SPECIFICATION SHEET

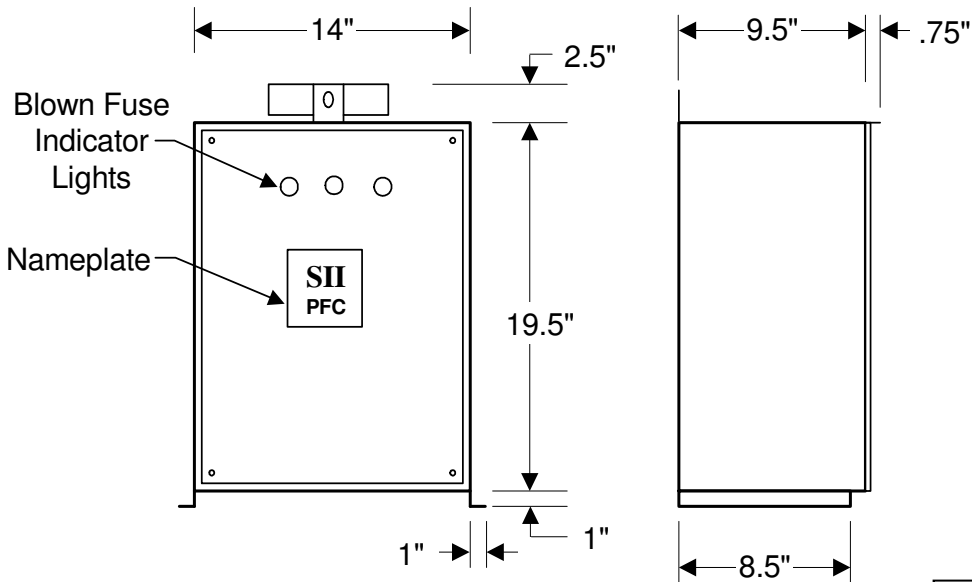

Internal Wiring Diagram

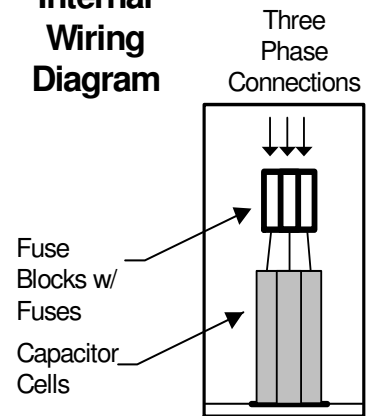

MODEL M025.0-240-FPL
25 KVAR 240VOLT Fused with Pilot Lights
Three Phase 60 Hz NEMA 3R Enclosure
Rated Current: 60.1 Amps
Recommended Wire Size: 4 AWG
APPROX. WEIGHT 56 LBS. EACH

OPTIONS:

- ◆ Built-In Contactor
- ◆ Built-In Circuit Breaker
- ◆ Third Leg Fusing

Life Expectancy: 20 years
Temperature: -40°C to +50°C
Discharge Resistors: Included, will reduce residual voltage to less than 50 volts in one minute after removal from service.
Pressure Sensitive Interrupter in each capacitor cell.

Self Clearing Design

Enclosures are rated NEMA 3R, Outdoor/Indoor.
 Provisions for wall, pole, or floor mounting are included.

STEELMAN ADVANTAGE
OPTION

480Volt, 70°C rated capacitors

**ENHANCES CAPACITOR
LIFE & PERFORMANCE
CHARACTERISTICS**



TWO YEAR LIMITED WARRANTY!

STEELMAN INDUSTRIES, INC.

2706 HWY. 135 N P.O. BOX 1461 KILGORE, TEXAS 75662

PHONE: (903) 984-3061 FAX: (903) 984-1384