

STEELMAN POWER CAPACITORS SPECIFICATION SHEET

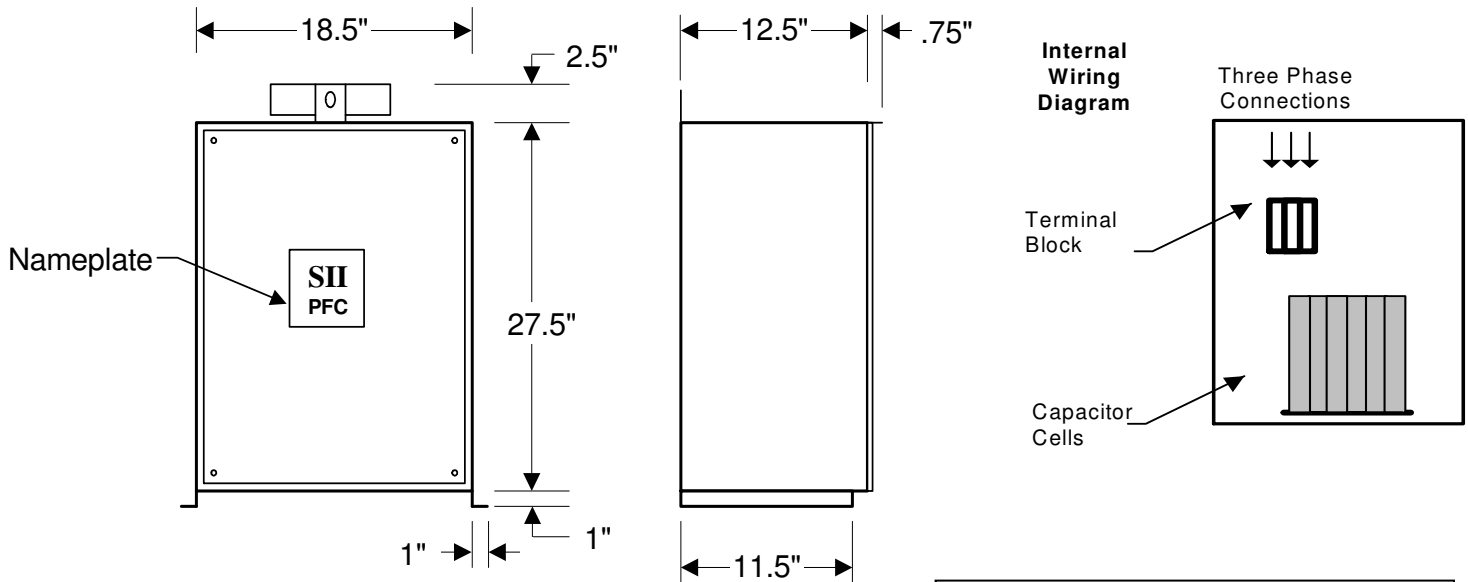

MODEL M080.0-480-NF
80 KVAR 480 VOLT Non Fused
Three Phase 60 Hz NEMA 3R Enclosure
Rated Current: 96.2 Amps
Recommended Wire Size: 1 AWG
APPROX. WEIGHT 78 LBS. EACH

AVAILABLE OPTIONS:

- ◆ Built-In Contactor
- ◆ Built-In Circuit Breaker

Note: dimensions may change with added options.

Enclosures are rated NEMA 3R, Outdoor/Indoor.
 Provisions for wall, pole, or floor mounting are included.

Life Expectancy: 20 years
Temperature: -40°C to +50°C
Discharge Resistors: Included, will reduce residual voltage to less than 50 volts in one minute after removal from service.
Pressure Sensitive Interrupter in each capacitor cell.

Self Clearing Design

STEELMAN ADVANTAGE
OPTION

600Volt, 70°C rated capacitors

**ENHANCES CAPACITOR
 LIFE & PERFORMANCE
 CHARACTERISTICS**

TWO YEAR LIMITED WARRANTY!



STEELMAN INDUSTRIES, INC.

2800 HWY. 135 N P.O. BOX 1461 KILGORE, TEXAS 75662
 PHONE: (903) 984-3061 FAX: (903) 984-1384